

LTS-RN5570

		产品型号	LTS-RN5570
		LED发光色	R(红)/W(白)
单位	mm (毫米)	输入电压	DC 24V(max)
比例	1:1	消耗功率	/
版本	NO 1.4	电缆极性	1:+, 2:NC, 3:-

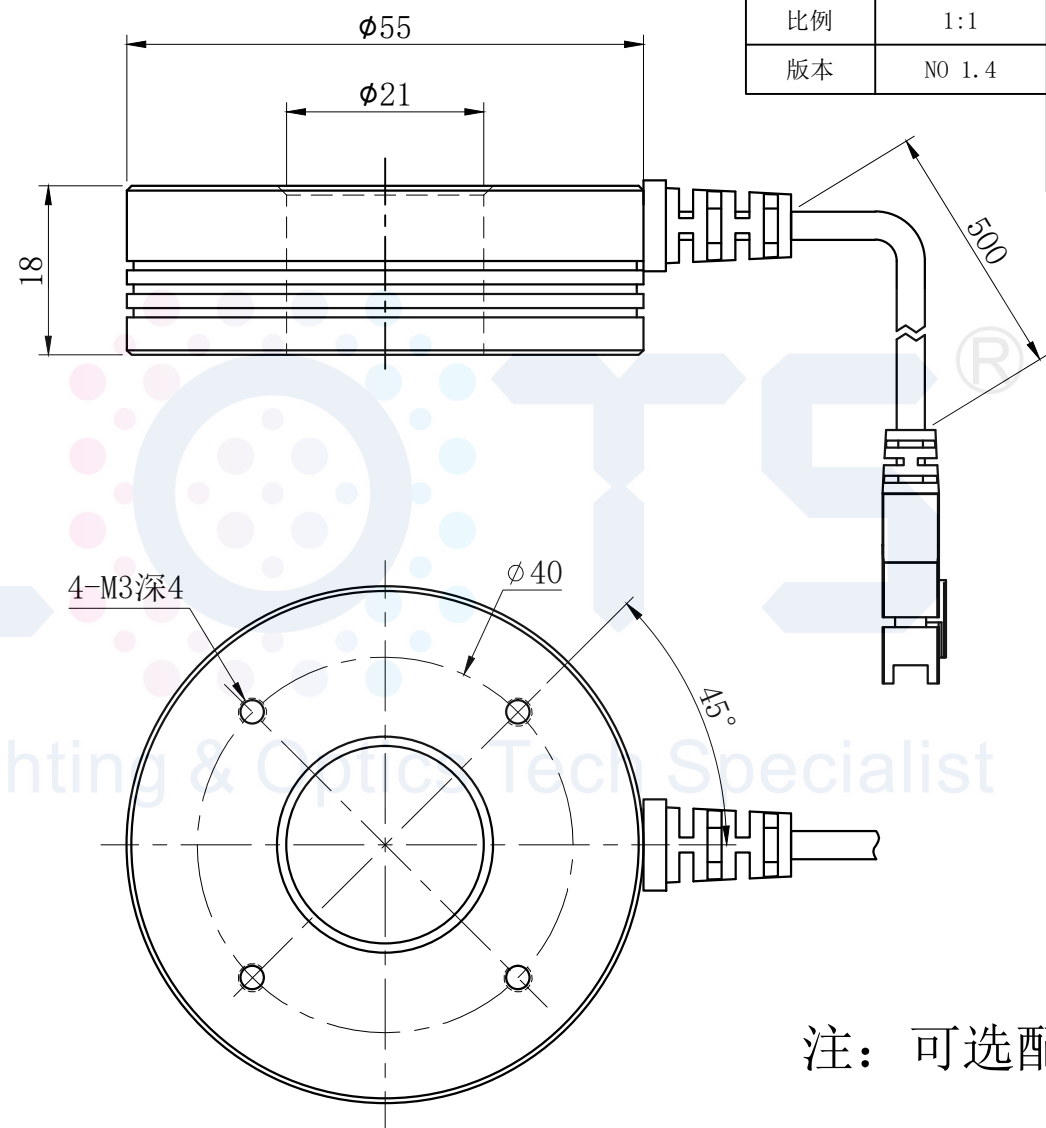

注：可选配平面漫射板

